

Article number: 604145038085

Description: Timing belt pulley with hub  
HTD 38 14M 85

## Measures

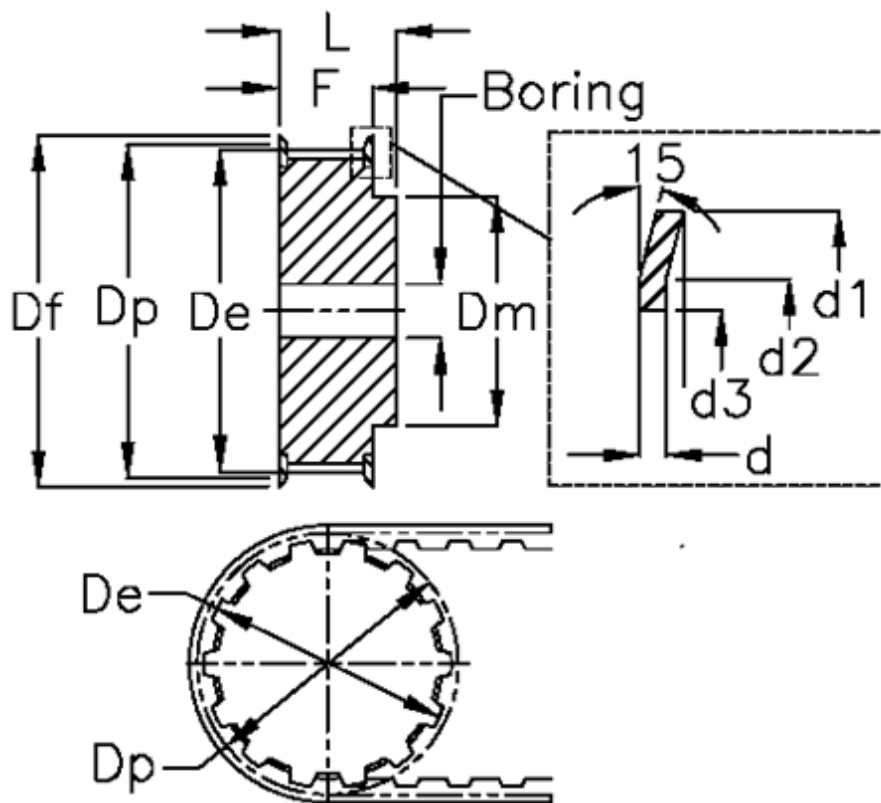

Bore = 32	Dp = 169.34
d = 2.5	F = 102
d1 = 184	Flange type = F55
d2 = 168	L = 117
d3 = 135	Tooth number = 38
De = 166.6	Type = 14M
Df = 184	Weight = 15.15
Dm = 120	Width = 85